

9468-ET

10/100Mb Ethernet Isolator



Instruction Manual

INM9468



CONTENTS

- 1. FEATURES 1
- 2 DESCRIPTION 2
- 3. INSTALLATION 2
 - 3.1 Protection 2
 - 3.2 Mechanical mounting 2
 - 3.3. Electrical connections 3
 - 3.4 Label marking 4
- 4 ENVIRONMENTAL 4
- 5 WASTE REMOVAL INFORMATION 4
- 6 APPROVALS 4
- 7 ACCESSORIES 5
- ATEX SAFETY INSTRUCTIONS 6



1. FEATURES

- ◆ Intrinsically Safe ATEX / IECEx certified
- ◆ FM / CSA approvals (pending)
- ◆ Ga Ex ia IIC T4 GD (surface), Ma Ex ia I M1 (mining)
- ◆ Zone 2 / Safe Area mounting with Hazardous Area connections into Zone 1 and 0.
- ◆ Interfaces Zone 2 and non-approved devices to the Intrinsically Safe 9400 series.
- ◆ Total galvanic isolation (Um=253Vac) from Safe to Hazardous RJ45 ports
- ◆ Single Safe Area supply: 20...30V dc @ 220mA
- ◆ Extended temperature range (-20°C...+70°C)
- ◆ PoEx™ - "Power over Ethernet" power sourcing equipment - distributes device supplies via the RJ45 ports*
- ◆ 10/100Mb Ethernet twisted pair (Cat5e) RJ45 Connections (100m max)
- ◆ Status LED's for:
 - 'Power On'
 - Safe Area UTP 'Link 10Mb' or 'Link 100Mb' Established
 - Safe Area UTP 'Tx/Rx Activity'
 - Hazardous Area UTP 'Link 10Mb' or 'Link 100Mb' Established
 - Hazardous Area UTP 'Tx/Rx Activity'
- ◆ Transparent operation – 10/100Mbps, Full/Half Duplex with Auto-Negotiation
- ◆ Supports IEEE 802.3: 10Base-T, 100Base-TX
- ◆ DIN-rail mounting module

**Note – PoEx is a simple adaptation of the IEEE 802.3af Power over Ethernet (PoE) standard to bring the benefits to the 9400 Range of Hazardous Area devices. This allows two spare pairs in the existing Cat5e cable to distribute the power supply from a 9466-ET Ethernet Switch (Power Sourcing Equipment – PSE) to each of the devices connected to its five ports (PD – Powered Device). This adaptation is necessary due to restrictions for Hazardous Area use. It is not implied that the device conforms to the 802.3af (PoE) standard.*

2 DESCRIPTION

The 9468-ET 10/100Mbps Ethernet Isolator allows the interconnection of a Zone 2 or un-certified Safe Area device to the Intrinsically Safe 9400 series of Ethernet networking products, operating in the Hazardous Area.

The isolator provides a compact alternative solution to fibre optic cable and media converters and for when it is desirable to use Cat5e cables in preference to fibre.

The module requires a single supply from the Safe Area of 20...30Vdc at approx 220mA.

3. INSTALLATION



WARNING: This equipment must be installed, operated and maintained only by trained competent personnel and in accordance with all appropriate international, national and local standard codes of practice and site regulation for intrinsically safe apparatus and in accordance with the instructions contained here.

3.1 Protection

The module requires mounting within an enclosure providing a degree of protection of at least IP6x, in accordance with EN60529 and in a manner that does not impair the existing creepage and clearance distances. The enclosure must also comply with the requirements of Clauses 7 and 8 of EN50014 and be sealed to prevent the ingress of dust.

3.2 Mechanical mounting

3.2.1 DIN rail mounting

The module will 'snap-fit' onto standard DIN rail (TS35) to EN 50022.

1. Tilt the module to engage the top DIN rail clips then rotate down and press to the DIN rail until the lower spring clip is properly engaged.

3.2.2 Flat panel mounting

The module has two fixing holes to enable it to be mounted with two M3.5 screws. Use the template on the previous page to establish hole positions. Height off rail - excluding cables = 125mm.

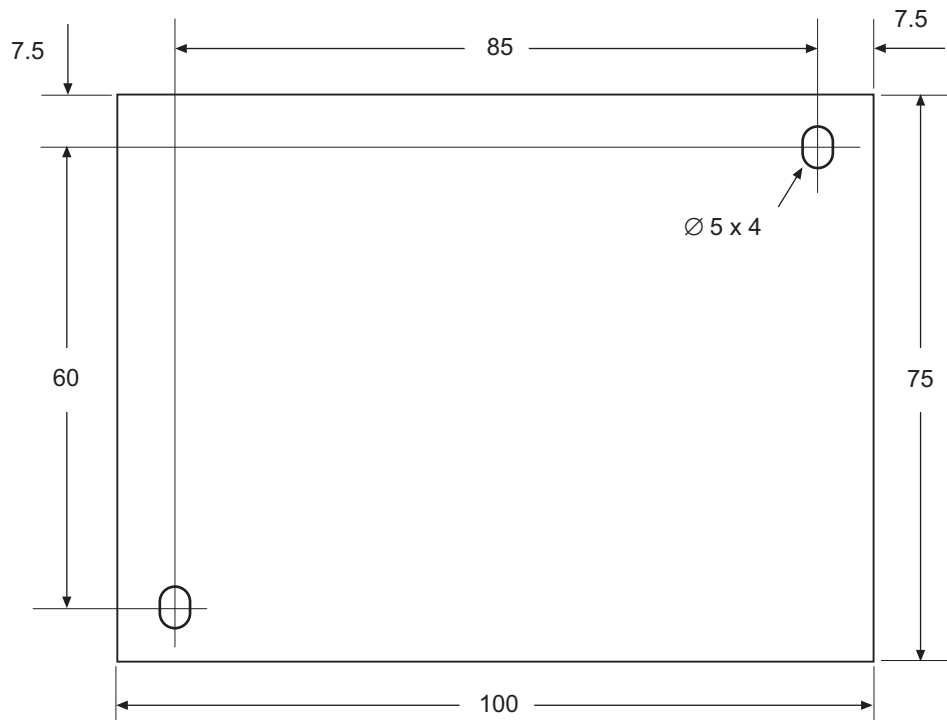

3.3. Electrical connections

3.3.1 Screw Terminals

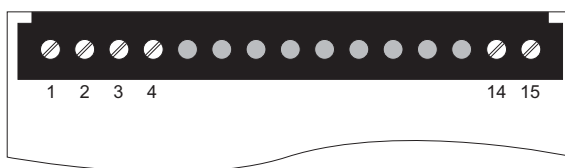

Terminal No.	Function
1	+20...30V dc in
2	+20...30V dc in
3	0V
4	0V
5–13	No connection
14	Supply in +12V - PoEx †
15	Supply in 0V - PoEx †

Note: Terminal pairs 1+2 and 3+4 are linked internally.

† To use PoEx, connect IS supply to terminals 14 & 15 (marked blue).



WARNING: The supply for PoEx must be derived from a suitably certified, intrinsically safe supply.

3.3.2 Front Panel Connectors

SAFE AREA - 10/100 BASE-T - Ethernet RJ45

(TX/RX crossed MDI-X)

Pin No.	Function
1	RX +
2	RX –
3	TX +
4	
5	
6	TX –
7	
8	

HAZARDOUS AREA - 10/100 BASE-T - Ethernet RJ45

(TX/RX crossed MDI-X) Connector marked blue

Pin No.	Function
1	RX +
2	RX –
3	TX +
4	Supply 12V - PoEx †
5	Supply 12V - PoEx †
6	TX –
7	Supply 0V - PoEx †
8	Supply 0V - PoEx †

† When supply has been connected to screw terminals 14 & 15.

When connecting the Cat5e cable to another device a straight connected RJ45 cable is used, a crossover cable is not required as the RJ45 connector performs the X-over.

A Crossover cable *is required* when interconnecting two 9468 modules.

It is recommended that Cat5e cables for Hazardous Area Zone 1 use are 'Blue' in colour and are of good quality (see accessories section), the Safe Area cables being a colour other than blue to aid identification.

3.4 Label marking

After installation, the product label should be permanently marked to indicate the type of area (safe or Zone 2) in which it has been mounted. Two tick (check) boxes are provided on the product label.

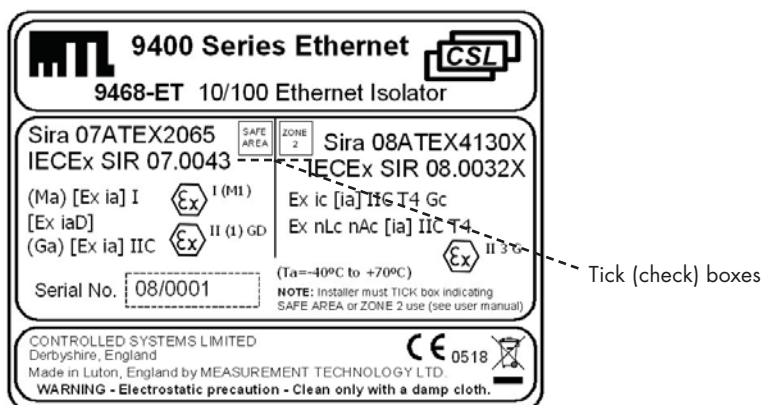

Place a single tick (check), with an indelible marker, in the appropriate box to indicate whether the box is being mounted in a safe area or a Zone 2 hazardous area.

Note: When a 9468-ET isolator has been used in (and marked for) a safe area, it may NOT be used in future in a Zone 2 hazardous area.

4 ENVIRONMENTAL

Operating Temperature	-20°C...+70°C
Storage Temperature	-20°C...+70°C
Humidity	5...95% RH, non condensing

5 WASTE REMOVAL INFORMATION



The electronic equipment within must not be treated as general waste. By ensuring that this product is disposed of correctly you will be helping to prevent potentially negative consequences for the environment and human health, which could otherwise be caused by incorrect waste handling of this product.

For more detailed information about the take-back and recycling contact MTL.

6 APPROVALS

The operating parameters must not exceed those as detailed on the certificate.

Region	Europe (ATEX)	International IECEX	USA	Canada
Authority	SIRA	SIRA	FM	CSA
Standard	EN 60079-0:2006, EN 60079-11:2007, IEC 60079-26:2006, IEC 61241-0:2004, IEC 61241-11:2005	IEC 60079-0:2004, IEC 60079-11:2006, IEC 60079-26:2006, IEC 61241-0:2004, IEC 61241-11:2005		
Approved for	Ex II (1) GD Ex I (M1) (Ga) [Ex ia] IIC [Ex iaD] (Ma) [Ex ia] I (Ta = -40°C to +70°C)*	(Ga) [Ex ia] IIC [Ex ia D] (Ma) [Ex ia] I (Ta = -40°C to +70°C)*		
Cert. no.	Sira 07ATEX2065	IECEX SIR 07.0043	Pending	Pending

* (see specification for operating temperature range)

Region	Europe (ATEX)	International IECEx	USA	Canada
Authority	SIRA	SIRA	FM	CSA
Standard	EN 60079-0:2006, IEC 60079-0:2007†, EN 60079-11:2007, EN 60079-15:2005, IEC 60079-26:2006	IEC 60079-0:2004, IEC 60079-11:2006, IEC 60079-15:2005-03		
Approved for	⊕ II 3 G Ex ic (ia) IIC T4 Gc (Ta = -40°C to +70°C)* Ex nLc nAc (ia) IIC T4 (Ta = -40°C to +70°C)*	Ex ic [ia] IIC T4 Gc (Ta = -40°C to +70°C)* Ex nLc nAc [ia] IIC (Ta = -40°C to +70°C)*		
Cert. no.	Sira 08ATEX4130X	IECEx SIR 08.0032X		

† (for guidance on the Gc, nLc & nAc marking) * (see specification for operating temperature range)

- ◆ 2004/108/EC EMC Directive
- ◆ 2006/95/EC Low Voltage Directive

7 ACCESSORIES

For interconnecting the 9460-ET range of products, we offer approved RJ45 Cat5e UTP cables in various standard lengths (0.5...100m)

Ordering details

Copper Twisted Pair UTP Patch Cable (Blue) pre-terminated RJ45-RJ45 connectors

Part No. CSL9405-xx (-xx is used to signify the length of the cable.)

ATEX SAFETY INSTRUCTIONS

The following information is in accordance with the Essential Health and Safety Requirements (Annex II) of the EU Directive 94/9/EC [the ATEX Directive - safety of apparatus] and is provided for those locations where the ATEX Directive is applicable.

General

- a. This equipment must only be installed, operated and maintained by competent personnel. Such personnel shall have undergone training, which included instruction on the various types of protection and installation practices, the relevant rules and regulations, and on the general principles of area classification. Appropriate refresher training shall be given on a regular basis. [See clause 4.2 of EN 60079-17].
- b. This equipment has been designed to provide protection against all the relevant additional hazards referred to in Annex II of the directive, such as those in clause 1.2.7.
- c. This equipment has been designed to meet the requirements of intrinsically safe electrical apparatus in accordance with EN 60079-0, EN 60079-11 and EN 60079-26.

Installation

- a. reference to the IEC code of practice IEC 60079-14. In addition, particular industries or end users may have specific requirements relating to the safety of their installations and these requirements should also be met. For the majority of installations the Directive 1999/92/EC [the ATEX Directive - safety of installations] is also applicable.
- b. Unless already protected by design, this equipment must be protected by a suitable enclosure against:
 - i) mechanical and thermal stresses in excess of those noted in the certification documentation and the product specification.
 - ii) aggressive substances, excessive dust, moisture and other contaminants.
- c. This apparatus is intrinsically safe electrical apparatus and is normally mounted in a hazardous area. When mounted in a Zone1 location the apparatus must be provided with an enclosure, which offers an additional degree of protection appropriate to the area classification.

Special conditions for safe use

- a. The non-metallic enclosure of the 'ic' certified 9468-ET 10/100 Ethernet Isolator module does not satisfy Table 4 of EN 60079-0:2006 for equipment protection level Gc and could be a potential electrostatic charging hazard, this must be taken into consideration during the installation of the modules.
- b. The 'nLc' 'nAc' certified 9468-ET 10/100 Ethernet Isolator module shall be installed in an ATEX Component Approved Ex 'e' enclosure that provides a level of protection appropriate for its intended environment of use. The minimum level of ingress protection provided shall be IP54.

Inspection and maintenance

- a. Inspection and maintenance should be carried out in accordance with European, national and local regulations which may refer to the IEC standard IEC 60079-17. In addition specific industries or end users may have specific requirements which should also be met.
- b. Access to the internal circuitry must not be made during operation.







Repair

This product cannot be repaired by the user and must be replaced with an equivalent certified product.

Marking

Each device is marked in accordance with the Directive and CE marked with the Notified Body Identification Number.

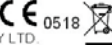
This information applies to products manufactured during or after the year 2009.

 9400 Series Ethernet			
9468-ET 10/100 Ethernet Isolator			
Sira 07ATEX2065 IECEx SIR 07.0043		<input type="checkbox"/> SAFE AREA <input type="checkbox"/> ZONE 2	Sira 08ATEX4130X IECEx SIR 08.0032X
(Ma) [Ex ia] I  [Ex iaD] (Ga) [Ex ia] IIC 		Ex ic [ia] IIC T4 Gc Ex nLc nAc [ia] IIC T4 	
Serial No. 08/0001		(Ta=-40°C to +70°C) NOTE: Installer must TICK box indicating SAFE AREA or ZONE 2 use (see user manual)	
CONTROLLED SYSTEMS LIMITED Derbyshire, England Made in Luton, England by MEASUREMENT TECHNOLOGY LTD.		 	
WARNING - Electrostatic precaution - Clean only with a damp cloth.			

MTL Instruments Pty Limited

1/30 Canvale Road
Canning Vale
Perth, WA 6155
Australia
Tel: +61 (0)8 9455 2994 Fax: +61 (0)8 9455 2805
E-mail: enquiries@mtlaus.com.au

MTL Canada Safety Instrumentation

#102, 4249 97 Street
Edmonton, Alberta
Canada T6E 5Y7
Tel: +1 780 485 3132 Fax: +1 780 485 3122
E-mail: cinfo@mtlnh.com

MTL Instruments China Co. Ltd.

Room 1002A, The Gateway
No 10 Yabao Road, Chaoyang District
Beijing 100020
China
Tel: +86 010 8562 5718/5720/5721 Fax: +86 010 8562 5725
E-mail: bjsales@mtl-inst.cn

MTL Instruments sarl

Les Carrés du Parc
10 rue des Rosiéristes
69410 Champagne au Mont d'Or
France
Tel: +33 (0)4 78 64 98 32 Fax: +33 (0)4 78 35 79 41
E-mail: info@mtl-inst.fr

MTL Instruments GmbH

An der Gumpgesbrücke 17
D-41564 Kaarst
Germany
Tel: +49 (0)2131 718930 Fax: +49 (0)2131 7189333
E-mail: info@mtl.de

MTL India

No. 36, Nehru Street
Off Old Mahabalipuram Road
Sholinganallur
Chennai - 600 119
India
Tel: + 91 (0)44 24501660/24501857 Fax: + 91 (0)44 24501463
E-mail: sales@mtlindia.com

MTL Italia srl

Via Cantù 11
I - 20092 Cinisello Balsamo MI
Italy
Tel: +39 (0)2 61802011 Fax: +39 (0)2 61294560
E-mail: info@mtl-inst.it

MTL Instruments KK

3rd Floor, Gotanda Masujima Building
1-8-13 Higashi-Gotanda, Shinagawa-Ku
Tokyo 141-0022
Japan
Tel: +81 (0)3 5420 1281 Fax: +81 (0)3 5420 2405
E-mail: sales@mtlkk.co.jp

MTL Instruments BV

PO Box 55, 6680 AB Bommel
de Houtakker 36, 6681 CW Bommel
The Netherlands
Tel: +31 (0)481 450250 Fax: +31 (0)481 450260
E-mail: info@mtlbenelux.com

MTL Instruments Pte Limited

31 Ubi Road 1
#04-01 Aztech Building
Singapore 408694
Tel: +65 6 487 7887 Fax: +65 6 487 7997
E-mail: sales@mtlsing.com.sg

MTL Instruments

Villa No. 4, Sector 2-17, Street 6
PO Box 53234,
Abu Dhabi, UAE
Tel: +971 2 446 6840 Fax: +971 2 446 6841
E-mail: mtlgulf@mtl-inst.com

Measurement Technology Limited

Power Court, Luton, Bedfordshire
England LU1 3JJ
Tel: +44 (0)1582 723633 Fax: +44 (0)1582 422283
E-mail: enquiry@mtl-inst.com

MTL Incorporated

4001 W. Sam Houston Parkway N., Suite 150
Houston TX 77043
USA
Tel: +1 281 571 8065 Fax: +1 281 571 8069
E-mail: info@mtl-inst.com

